



Product Selection Guide

- Size and Performance Data .....LS-DH-2
- Features and Options .....LS-DH-3
- Combination Assemblies ..... LS-DH-4
- Glazing Performance

  - Vent Units..... LS-DH-6
  - Fixed Units ..... LS-DH-8

- Grille Types .....LS-DH-11
- Size Tables

  - Double-Hung with GBG's and SDL's..... LS-DH-12
  - Fixed and Transoms with GBG's and SDL's..... LS-DH-13
  - Replacement Sizes with Grilles-Between-the-Glass .....LS-DH-14

- Special Sizes and Dimensions..... LS-DH-17
- Design Data

  - Vent Units.....LS-DH-18
  - Fixed and Transoms .....LS-DH-19
  - Replacement Double-Hung Venting .....LS-DH-20
  - Replacement Fixed and Transoms ..... LS-DH-22

- Detailed Product Description ..... LS-DH-23
- Unit Sections .....LS-DH-24

**Document Navigation Tips:**

Items listed in the table of contents above are active links that will take you to the corresponding page.

**Supporting documents for this product:**

Test Reports:

[https://media.pella.com/professional/adm/CertificationReports/Test\\_Reports\\_LS-Dual.pdf](https://media.pella.com/professional/adm/CertificationReports/Test_Reports_LS-Dual.pdf)

CSI Specs (readable using Microsoft Word or other text editing application):

[https://media.pella.com/professional/adm/Wood-CSI\\_Specs/08552.rtf](https://media.pella.com/professional/adm/Wood-CSI_Specs/08552.rtf)

Detailed Product Description (readable using Microsoft Word or other text editing application):

[https://media.pella.com/professional/adm/Clad-Wood-LS/PellaLifestyleSrs-DH\\_DPD.rtf](https://media.pella.com/professional/adm/Clad-Wood-LS/PellaLifestyleSrs-DH_DPD.rtf)

Size Tables (requires appropriate CAD software to read and use):

[https://media.pella.com/professional/adm/Clad-Wood-LS/LSCDHE\\_D.dwg](https://media.pella.com/professional/adm/Clad-Wood-LS/LSCDHE_D.dwg)

CAD cross sections (requires appropriate CAD software to read and use):

[https://media.pella.com/professional/adm/Clad-Wood-LS/LS-DH\\_XSEC\\_D.dwg](https://media.pella.com/professional/adm/Clad-Wood-LS/LS-DH_XSEC_D.dwg)

3D & BIM (requires appropriate software to read and use):

[https://media.pella.com/professional/adm/RevitFiles/LS-Revit/Window-Double-Hung-Pella-Lifestyle\\_Series.zip](https://media.pella.com/professional/adm/RevitFiles/LS-Revit/Window-Double-Hung-Pella-Lifestyle_Series.zip)

Sketchup (requires appropriate software to read and use):

[https://media.pella.com/professional/adm/Clad-Wood-LS/PellaSKP\\_LifestyleSeries\\_Double-Hung.zip](https://media.pella.com/professional/adm/Clad-Wood-LS/PellaSKP_LifestyleSeries_Double-Hung.zip)

Combination Recommendations:

[https://media.pella.com/professional/adm/Clad-Wood/D\\_Combinations.pdf](https://media.pella.com/professional/adm/Clad-Wood/D_Combinations.pdf)

Installation Details:

[https://media.pella.com/professional/adm/Clad-Wood/F\\_InstallationDetails.pdf](https://media.pella.com/professional/adm/Clad-Wood/F_InstallationDetails.pdf)

Bay/Bow Details:

[https://media.pella.com/professional/adm/Clad-Wood/Pella-Wood\\_BayBowWindows.pdf](https://media.pella.com/professional/adm/Clad-Wood/Pella-Wood_BayBowWindows.pdf)

The information published in this document is believed to be accurate at the time of publication. However, because we are constantly working to improve our products, specifications are subject to change without notice. Consult your local Pella representative for up-to-date product information and availability.

Microsoft and Microsoft Word are registered trademarks of Microsoft Corp.



# Lifestyle Series Double-Hung

## Size and Performance Data

	Dual-Pane
<b>Sizes</b>	
Standard double-hung vent/fixed sizes	●
Transom sizes	●
Egress sizes	●
Special sizes available	●
<b>Performance<sup>1</sup></b>	
Meets or Exceeds AAMA / WDMA Ratings	H-LC25-LC50 Hallmark Certified
Air Infiltration (cfm/ft <sup>2</sup> of frame @ 1.57 psf wind pressure) <sup>2</sup>	0.11
Water Resistance	7.5 psf
Design Pressure	25–50 psf
<b>Other Performance Criteria</b>	
Forced Entry Resistance Level (Minimum Security Grade) <sup>3</sup>	10
Operating Force (lb) Initiate Motion / Maintain Motion (of Hallmark tested size and glazing) <sup>4</sup>	40/40

### Sound Transmission Class / Outdoor-Indoor Transmission Class

Product	Frame Size Tested <sup>5</sup>	Glazing System				STC Rating	OITC Rating
		Overall Glazing Thickness	Exterior Glass Thickness	Interior Glass Thickness	Third Pane Thickness (HGP)		
Pella Lifestyle Series Double-Hung	37" x 59"	1 1/16"	2.5mm	2.5mm	—	27	23
	37" x 59"	1 1/16"	5mm	3mm	—	31	27

(—) = Not Available

(1) Maximum performance for single unit when glazed with the appropriate glass thickness. See Design Data pages in this section for specific product performance class and grade values.

(2) Published performance data for air infiltration is determined by testing a minimum of four (4) products of NFRC model size. Testing is conducted in accordance with ASTM E283. Air infiltration ratings for products will differ by size. The performance data does not apply to combination assemblies unless noted. Actual product performance may vary for a number of reasons including installation and product care.

(3) The higher the level, the greater the product's ability to resist forced entry.

(4) Glazing configurations may result in higher operational forces.

(5) ASTM E 1425 defines standard sizes for acoustical testing. Ratings achieved at that size are representative of all sizes of the same configuration.



# Lifestyle Series Double-Hung

## Features and Options

Standard	Options / Upgrades
<b>Glazing</b>	
<b>Glazing Type</b>	
Dual-Pane Insulating Glass	—
<b>Insulated Glass Options/Low-E Types</b>	
Advanced Low-E	SunDefense™ Low-E
	SunDefense+ Low-E
	AdvancedComfort Low-E
	NaturalSun Low-E
	NaturalSun+ Low-E
<b>Additional Glass Options</b>	
Annealed Glass	STC Glazing Options
	Tempered Glass
	Obscure Glass <sub>1</sub>
<b>Gas Fill/High Altitude</b>	
Argon	High altitude (Air-filled only)
<b>Exterior</b>	
EnduraClad® protective finish	—
<b>Cladding Colors</b>	
12 Standard colors <sub>1</sub>	—
<b>Interior<sub>1</sub></b>	
Unfinished wood	Factory primed
	Factory prefinished paint <sub>1</sub>
	Factory prefinished stain <sub>1</sub>
<b>Wood Types</b>	
Pine	—
<b>Hardware</b>	
<b>Finishes</b>	
Champagne, Matte Black, White or Brown	Oil Rubbed Bronze, Satin Nickel
<b>Sash Locks/Sash Lifts</b>	
Cam-action lock	Sash lifts <sub>2</sub>
<b>Tilt-Wash Cleaning</b>	
Tilt to interior on both sashes	—
<b>Grilles</b>	
<b>Grilles-Between-the-Glass</b>	
—	Traditional, Prairie, Top Row, Cross, Custom - Equally Divided
<b>Simulated Divided Light with Optional Spacer<sub>3</sub></b>	
—	Traditional, Prairie, Top Row, Cross, Custom - Equally Divided
<b>Screens</b>	
—	Full-Size InView™ screens, Hidden Screen <sub>1</sub>

(—) = Not Available

(1) Contact your local Pella sales representative for current color options.

(2) Sold separately for Pella® Lifestyle Series double-hung windows.

(3) Available with Low-E argon-insulated glass only.



# Lifestyle Series Double-Hung

## Combination Assemblies

Combinations are a great way to create visual interest in any project. A combination is an assembly formed by two or more separate windows or doors whose frames are mullioned together by a direct or reinforcing mullion.

Pella window combinations are available in an endless variety of arrangements. Refer to Combinations section for requirements and limitations.

Contact your local Pella sales representative for more information.

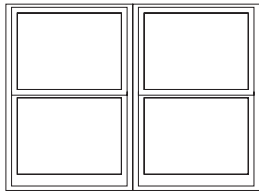

Two-Wide

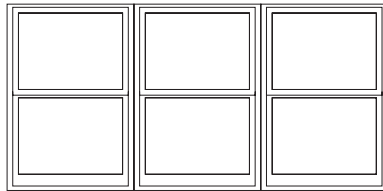

Three-Wide Equal

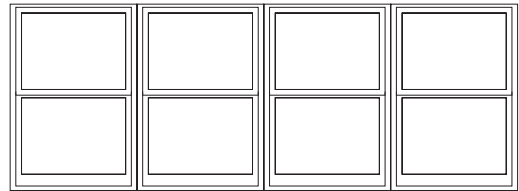

Four-Wide Equal

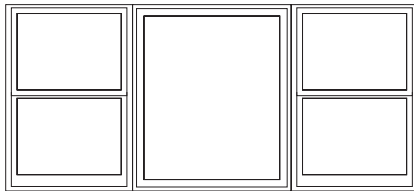

Center Fixed with Flankers

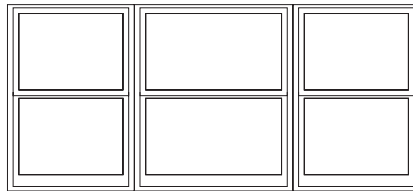

Three-Wide Unequal

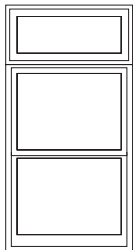

Transom over Single

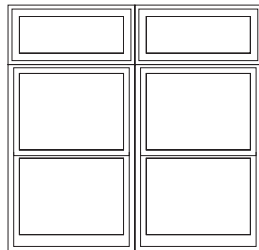

Two-Wide Transoms over Two-Wide

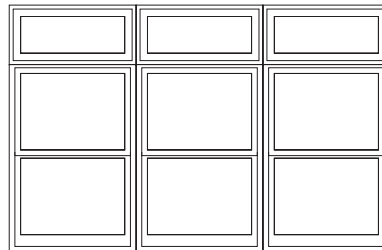

Three-Wide Transoms over Three-Wide

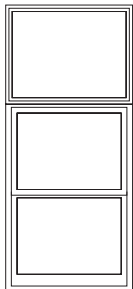

Clad Frame over Single

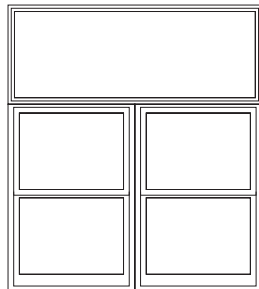

Single Clad Frame over Two-Wide

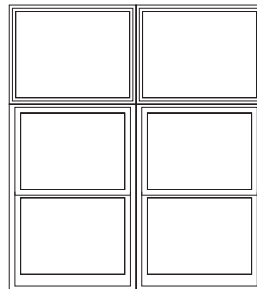

Two Wide Clad Frame over Two-Wide



# Lifestyle Series Double-Hung

## Combination Assemblies

Combinations are a great way to create visual interest in any project. A combination is an assembly formed by two or more separate windows or doors whose frames are mullioned together by a direct or reinforcing mullion.

Pella window combinations are available in an endless variety of arrangements. Refer to Combinations Section for requirements, and limitations.

Contact your local Pella sales representative for more information.

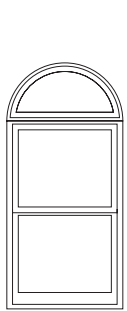

Half Circle over Single

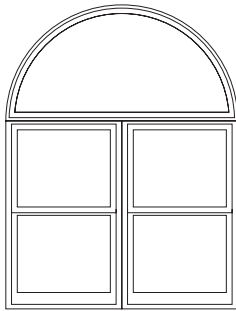

Half Circle over Two-Wide

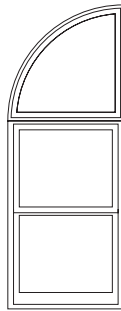

Left Quarter Circle over Single



Right Quarter Circle over Single

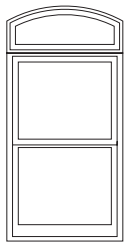

Arch Head over Single

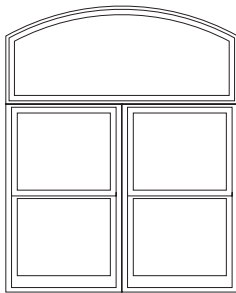

Arch Head over Two-Wide

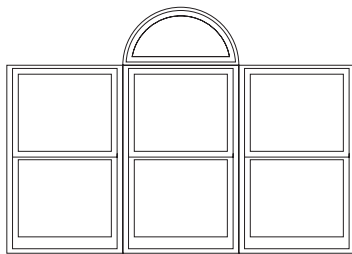

Half Circle centered on Three-Wide Equal

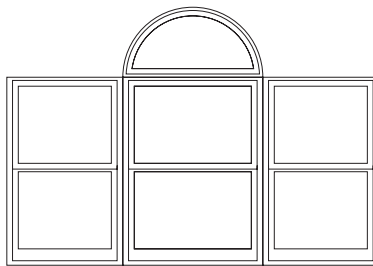

Half Circle over Three-Wide Unequal

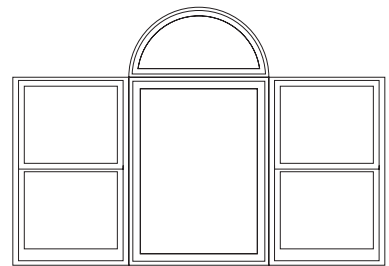

Half Circle over Center Fixed with Flankers



# Lifestyle Series Double-Hung

## Glazing Performance - Total Unit

Glazing Thickness	Type of Glazing	NFRC Certified Product #	Glass (mm)		Gap Fill	Performance Values <sup>1</sup>				Shaded Areas Meet ENERGY STAR® Performance Criteria in Zones Shown						
			Ext.	Int.		U-Factor	SHGC	VLT	CR	U. S.		Canada <sup>2</sup>				
										Zone		ER	Zone			
Dual-Pane Vent										N	NC	SC	S	CA		
11/16"	Advanced LowE IG	PEL-N-35-00514-00001	2.5	2.5	argon	0.30	0.30	0.56	56							
	with grilles-between-the-glass	PEL-N-35-00515-00001				0.30	0.27	0.50	56							
	with Simulated Divided Light	PEL-N-35-00516-00001				0.30	0.27	0.50	56							
11/16"	Advanced LowE IG	PEL-N-35-00517-00001	3	3	argon	0.30	0.30	0.56	55							
	with grilles-between-the-glass	PEL-N-35-00518-00001				0.30	0.27	0.50	55							
	with Simulated Divided Light	PEL-N-35-00519-00001				0.30	0.27	0.50	55							
11/16"	SunDefense™ Low-E IG	PEL-N-35-00550-00001	2.5	2.5	argon	0.29	0.22	0.52	56				S			
	with grilles-between-the-glass	PEL-N-35-00551-00001				0.29	0.20	0.47	56				S			
	with Simulated Divided Light	PEL-N-35-00552-00001				0.29	0.20	0.47	56				S			
11/16"	SunDefense Low-E IG	PEL-N-35-00553-00001	3	3	argon	0.29	0.22	0.52	55				S			
	with grilles-between-the-glass	PEL-N-35-00554-00001				0.29	0.20	0.46	55				S			
	with Simulated Divided Light	PEL-N-35-00555-00001				0.29	0.20	0.46	55				S			
11/16"	SunDefense+ Low-E IG	PEL-N-35-00568-00001	2.5	2.5	argon	0.25	0.22	0.51	45		NC	SC	S			
	with grilles-between-the-glass	PEL-N-35-00569-00001				0.25	0.20	0.46	45		NC	SC	S			
	with Simulated Divided Light	PEL-N-35-00570-00001				0.25	0.20	0.46	45		NC	SC	S			
11/16"	SunDefense+ Low-E IG	PEL-N-35-00571-00001	3	3	argon	0.25	0.22	0.51	44		NC	SC	S			
	with grilles-between-the-glass	PEL-N-35-00572-00001				0.25	0.20	0.45	44		NC	SC	S			
	with Simulated Divided Light	PEL-N-35-00573-00001				0.25	0.20	0.45	44		NC	SC	S			
11/16"	AdvancedComfort Low-E IG	PEL-N-35-00532-00001	2.5	2.5	argon	0.26	0.29	0.55	45							
	with grilles-between-the-glass	PEL-N-35-00533-00001				0.26	0.27	0.49	45							
	with Simulated Divided Light	PEL-N-35-00534-00001				0.26	0.27	0.49	45							
11/16"	AdvancedComfort Low-E IG	PEL-N-35-00535-00001	3	3	argon	0.26	0.29	0.55	44							
	with grilles-between-the-glass	PEL-N-35-00536-00001				0.26	0.26	0.49	44							
	with Simulated Divided Light	PEL-N-35-00537-00001				0.26	0.26	0.49	44							
11/16"	NaturalSun LowE IG	PEL-N-35-00478-00001	2.5	2.5	argon	0.30	0.56	0.64	55					34	CA	
	with grilles-between-the-glass	PEL-N-35-00479-00001				0.30	0.50	0.57	55							
	with Simulated Divided Light	PEL-N-35-00480-00001				0.30	0.50	0.57	55							
11/16"	NaturalSun LowE IG	PEL-N-35-00481-00001	3	3	argon	0.30	0.55	0.63	54					34	CA	
	with grilles-between-the-glass	PEL-N-35-00482-00001				0.30	0.49	0.57	54							
	with Simulated Divided Light	PEL-N-35-00483-00001				0.30	0.49	0.57	54							
11/16"	NaturalSun+ LowE IG	PEL-N-35-00496-00001	2.5	2.5	argon	0.26	0.51	0.63	44	N				35	CA	
	with grilles-between-the-glass	PEL-N-35-00497-00001				0.26	0.46	0.56	44	N						
	with Simulated Divided Light	PEL-N-35-00498-00001				0.26	0.46	0.56	44	N						
11/16"	NaturalSun+ LowE IG	PEL-N-35-00499-00001	3	3	argon	0.26	0.50	0.62	43	N				35	CA	
	with grilles-between-the-glass	PEL-N-35-00500-00001				0.26	0.45	0.55	43	N						
	with Simulated Divided Light	PEL-N-35-00501-00001				0.26	0.45	0.55	43	N						

R-Value = 1/U-Factor  
 SHGC = Solar Heat Gain Coefficient  
 VLT % = Visible Light Transmission  
 CR = Condensation Resistance  
 ER = Canadian Energy Rating

(1) Glazing performance values are calculated based on NFRC 100, NFRC 200 and NFRC 500. ENERGY STAR® values are updated to 2023 (version 7) criteria.  
 (2) The values shown are based on Canada's updated ENERGY STAR® 2020 initiative. Visit [www.energystar.gov](http://www.energystar.gov) for Energy Star guidelines.

Climate Zones

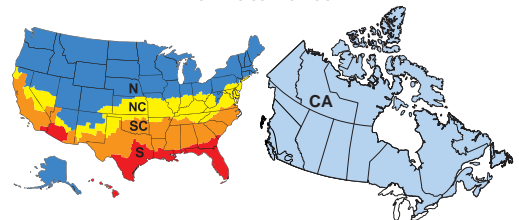



# Lifestyle Series Double-Hung

## Glazing Performance - Total Unit

Glazing Thickness	Type of Glazing	NFRC Certified Product #	Glass (mm)		Gap Fill	Performance Values <sup>1</sup>				Shaded Areas Meet ENERGY STAR® Performance Criteria in Zones Shown				
			Ext.	Int.		U-Factor	SHGC	VLT	CR	U. S.		Canada <sup>2</sup>		
										Zone		ER	Zone	
Dual-Pane Vent – High Altitude Glazing										N	NC	SC	S	CA
11/16"	Advanced LowE IG	PEL-N-35-00523-00001	2.5	2.5	air	0.33	0.30	0.57	52					
	with grilles-between-the-glass	PEL-N-35-00524-00001				0.33	0.27	0.50	52					
	with Simulated Divided Light	PEL-N-35-00525-00001				0.33	0.27	0.50	52					
11/16"	Advanced LowE IG	PEL-N-35-00526-00001	3	3	air	0.33	0.30	0.56	52					
	with grilles-between-the-glass	PEL-N-35-00527-00001				0.33	0.27	0.50	52					
	with Simulated Divided Light	PEL-N-35-00528-00001				0.33	0.27	0.50	52					
11/16"	SunDefense™ Low-E IG	PEL-N-35-00559-00001	2.5	2.5	air	0.33	0.22	0.52	53					
	with grilles-between-the-glass	PEL-N-35-00560-00001				0.33	0.20	0.47	53					
	with Simulated Divided Light	PEL-N-35-00561-00001				0.33	0.20	0.47	53					
11/16"	SunDefense Low-E IG	PEL-N-35-00562-00001	3	3	air	0.33	0.23	0.52	52					
	with grilles-between-the-glass	PEL-N-35-00563-00001				0.33	0.20	0.46	52					
	with Simulated Divided Light	PEL-N-35-00564-00001				0.33	0.20	0.46	52					
11/16"	SunDefense+ Low-E IG	PEL-N-35-00577-00001	2.5	2.5	air	0.28	0.22	0.51	42			SC	S	
	with grilles-between-the-glass	PEL-N-35-00578-00001				0.28	0.20	0.46	42			SC	S	
	with Simulated Divided Light	PEL-N-35-00579-00001				0.28	0.20	0.46	42			SC	S	
11/16"	SunDefense+ Low-E IG	PEL-N-35-00580-00001	3	3	air	0.28	0.22	0.51	41			SC	S	
	with grilles-between-the-glass	PEL-N-35-00581-00001				0.28	0.20	0.45	41			SC	S	
	with Simulated Divided Light	PEL-N-35-00582-00001				0.28	0.20	0.45	41			SC	S	
11/16"	AdvancedComfort Low-E IG	PEL-N-35-00541-00001	2.5	2.5	air	0.28	0.30	0.55	41					
	with grilles-between-the-glass	PEL-N-35-00542-00001				0.28	0.27	0.49	41					
	with Simulated Divided Light	PEL-N-35-00543-00001				0.28	0.27	0.49	41					
11/16"	AdvancedComfort Low-E IG	PEL-N-35-00544-00001	3	3	air	0.28	0.29	0.55	40					
	with grilles-between-the-glass	PEL-N-35-00545-00001				0.28	0.26	0.49	40					
	with Simulated Divided Light	PEL-N-35-00546-00001				0.28	0.26	0.49	40					
11/16"	NaturalSun LowE IG	PEL-N-35-00487-00001	2.5	2.5	air	0.34	0.56	0.64	52					
	with grilles-between-the-glass	PEL-N-35-00488-00001				0.34	0.50	0.57	52					
	with Simulated Divided Light	PEL-N-35-00489-00001				0.34	0.50	0.57	52					
11/16"	NaturalSun LowE IG	PEL-N-35-00490-00001	3	3	air	0.34	0.55	0.63	51					
	with grilles-between-the-glass	PEL-N-35-00491-00001				0.34	0.49	0.57	51					
	with Simulated Divided Light	PEL-N-35-00492-00001				0.34	0.49	0.57	51					
11/16"	NaturalSun+ LowE IG	PEL-N-35-00505-00001	2.5	2.5	air	0.28	0.51	0.63	41					
	with grilles-between-the-glass	PEL-N-35-00506-00001				0.28	0.46	0.56	41					
	with Simulated Divided Light	PEL-N-35-00507-00001				0.28	0.46	0.56	41					
11/16"	NaturalSun+ LowE IG	PEL-N-35-00508-00001	3	3	air	0.29	0.50	0.62	40					
	with grilles-between-the-glass	PEL-N-35-00509-00001				0.29	0.45	0.62	40					
	with Simulated Divided Light	PEL-N-35-00510-00001				0.29	0.45	0.55	40					

R-Value = 1/U-Factor  
 SHGC = Solar Heat Gain Coefficient  
 VLT % = Visible Light Transmission  
 CR = Condensation Resistance  
 ER = Canadian Energy Rating

(1) Glazing performance values are calculated based on NFRC 100, NFRC 200 and NFRC 500. ENERGY STAR® values are updated to 2023 (version 7) criteria.

(2) The values shown are based on Canada's updated ENERGY STAR® 2020 initiative. Visit [www.energystar.gov](http://www.energystar.gov) for Energy Star guidelines.

Climate Zones

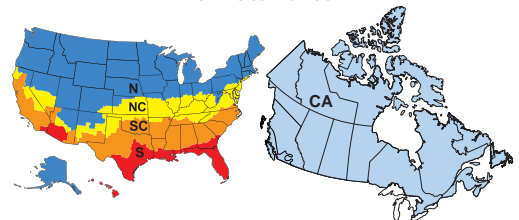



# Lifestyle Series Double-Hung

## Glazing Performance - Total Unit

Glazing Thickness	Type of Glazing	NFRC Certified Product #	Glass (mm)		Gap Fill	Performance Values <sup>1</sup>				Shaded Areas Meet ENERGY STAR® Performance Criteria in Zones Shown						
			Ext.	Int.		U-Factor	SHGC	VLT	CR	U. S.				Canada <sup>2</sup>		
										Zone				ER	Zone	
Dual-Pane Fixed										N	NC	SC	S	CA		
11/16"	Advanced LowE IG	PEL-N-229-00861-00001	2.5	2.5	argon	0.27	0.31	0.58	58							
	with grilles-between-the-glass	PEL-N-229-00862-00001				0.27	0.28	0.52	58							
	with Simulated Divided Light	PEL-N-229-00863-00001				0.28	0.28	0.52	58							
11/16"	Advanced LowE IG	PEL-N-229-00949-00001	3	3	argon	0.27	0.31	0.58	57							
	with grilles-between-the-glass	PEL-N-229-00950-00001				0.27	0.28	0.51	57							
	with Simulated Divided Light	PEL-N-229-00951-00001				0.28	0.28	0.51	57							
11/16"	Advanced LowE IG	PEL-N-229-00965-00001	4	4	argon	0.28	0.30	0.57	55							
	with grilles-between-the-glass	PEL-N-229-00966-00001				0.29	0.28	0.51	55							
	with Simulated Divided Light	PEL-N-229-00967-00001				0.29	0.28	0.51	55							
11/16"	SunDefense™ Low-E IG	PEL-N-229-01045-00001	2.5	2.5	argon	0.27	0.23	0.54	58			SC	S			
	with grilles-between-the-glass	PEL-N-229-01046-00001				0.27	0.21	0.48	58			SC	S			
	with Simulated Divided Light	PEL-N-229-01047-00001				0.28	0.21	0.48	58			SC	S			
11/16"	SunDefense Low-E IG	PEL-N-229-01053-00001	3	3	argon	0.27	0.23	0.53	57			SC	S			
	with grilles-between-the-glass	PEL-N-229-01054-00001				0.27	0.21	0.48	57			SC	S			
	with Simulated Divided Light	PEL-N-229-01055-00001				0.28	0.21	0.48	57			SC	S			
11/16"	SunDefense Low-E IG	PEL-N-229-01061-00001	4	4	argon	0.28	0.23	0.53	55			SC	S			
	with grilles-between-the-glass	PEL-N-229-01062-00001				0.29	0.21	0.47	55				S			
	with Simulated Divided Light	PEL-N-229-01063-00001				0.29	0.21	0.47	55				S			
11/16"	SunDefense+ Low-E IG	PEL-N-229-01493-00001	2.5	2.5	argon	0.23	0.22	0.53	46		NC	SC	S			
	with grilles-between-the-glass	PEL-N-229-01494-00001				0.23	0.20	0.47	46		NC	SC	S			
	with Simulated Divided Light	PEL-N-229-01495-00001				0.24	0.20	0.47	46		NC	SC	S			
11/16"	SunDefense+ Low-E IG	PEL-N-229-01501-00001	3	3	argon	0.23	0.22	0.52	45		NC	SC	S			
	with grilles-between-the-glass	PEL-N-229-01502-00001				0.23	0.20	0.47	45		NC	SC	S			
	with Simulated Divided Light	PEL-N-229-01503-00001				0.24	0.20	0.47	45		NC	SC	S			
11/16"	SunDefense+ Low-E IG	PEL-N-229-01509-00001	4	4	argon	0.24	0.22	0.52	43		NC	SC	S			
	with grilles-between-the-glass	PEL-N-229-01510-00001				0.25	0.20	0.46	43		NC	SC	S			
	with Simulated Divided Light	PEL-N-229-01511-00001				0.25	0.20	0.46	43		NC	SC	S			
11/16"	AdvancedComfort Low-E IG	PEL-N-229-00997-00001	2.5	2.5	argon	0.23	0.30	0.57	46		NC					
	with grilles-between-the-glass	PEL-N-229-00998-00001				0.23	0.27	0.51	46		NC					
	with Simulated Divided Light	PEL-N-229-00999-00001				0.24	0.27	0.51	46		NC					
11/16"	AdvancedComfort Low-E IG	PEL-N-229-01005-00001	3	3	argon	0.23	0.30	0.56	45		NC					
	with grilles-between-the-glass	PEL-N-229-01006-00001				0.23	0.27	0.50	45		NC					
	with Simulated Divided Light	PEL-N-229-01007-00001				0.24	0.27	0.50	45		NC					
11/16"	AdvancedComfort Low-E IG	PEL-N-229-01013-00001	4	4	argon	0.24	0.30	0.55	43		NC					
	with grilles-between-the-glass	PEL-N-229-01014-00001				0.25	0.27	0.50	43		NC					
	with Simulated Divided Light	PEL-N-229-01015-00001				0.25	0.27	0.50	43		NC					

R-Value = 1/U-Factor  
 SHGC = Solar Heat Gain Coefficient  
 VLT % = Visible Light Transmission  
 CR = Condensation Resistance  
 ER = Canadian Energy Rating

(1) Glazing performance values are calculated based on NFRC 100, NFRC 200 and NFRC 500. ENERGY STAR® values are updated to 2023 (version 7) criteria.  
 (2) The values shown are based on Canada's updated ENERGY STAR® 2020 initiative. Visit [www.energystar.gov](http://www.energystar.gov) for Energy Star guidelines.

Climate Zones

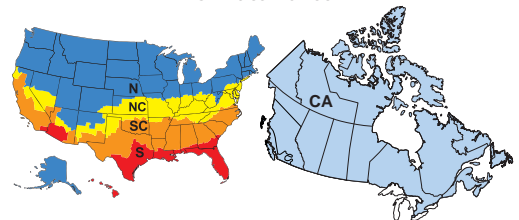





# Lifestyle Series Double-Hung

## Glazing Performance - Total Unit

Glazing Thickness	Type of Glazing	NFRC Certified Product #	Glass (mm)		Gap Fill	Performance Values <sup>1</sup>				Shaded Areas Meet ENERGY STAR® Performance Criteria in Zones Shown					
			Ext.	Int.		U-Factor	SHGC	VLT	CR	U. S.		Canada <sup>2</sup>			
										Zone			ER	Zone	
Dual-Pane Fixed (continued)										N	NC	SC	S	CA	
11/16"	NaturalSun LowE IG	PEL-N-229-00901-00001	2.5	2.5	argon	0.28	0.58	0.66	57					38	CA
	with grilles-between-the-glass	PEL-N-229-00902-00001				0.28	0.52	0.59	57					35	CA
	with Simulated Divided Light	PEL-N-229-00903-00001				0.29	0.52	0.59	57					34	CA
11/16"	NaturalSun LowE IG	PEL-N-229-00909-00001	3	3	argon	0.28	0.57	0.65	56					38	CA
	with grilles-between-the-glass	PEL-N-229-00910-00001				0.28	0.51	0.58	56					34	CA
	with Simulated Divided Light	PEL-N-229-00911-00001				0.29	0.51	0.58	56						
11/16"	NaturalSun LowE IG	PEL-N-229-00917-00001	4	4	argon	0.29	0.55	0.65	55					35	CA
	with grilles-between-the-glass	PEL-N-229-00918-00001				0.30	0.50	0.58	55						
	with Simulated Divided Light	PEL-N-229-00919-00001				0.30	0.50	0.58	55						
11/16"	NaturalSun+ LowE IG	PEL-N-229-01445-00001	2.5	2.5	argon	0.24	0.53	0.64	45	N				41	CA
	with grilles-between-the-glass	PEL-N-229-01446-00001				0.24	0.47	0.58	45	N				37	CA
	with Simulated Divided Light	PEL-N-229-01447-00001				0.25	0.47	0.58	45	N				36	CA
11/16"	NaturalSun+ LowE IG	PEL-N-229-01453-00001	3	3	argon	0.24	0.52	0.64	44	N				40	CA
	with grilles-between-the-glass	PEL-N-229-01454-00001				0.24	0.46	0.57	44	N				37	CA
	with Simulated Divided Light	PEL-N-229-01455-00001				0.25	0.46	0.57	44	N				35	CA
11/16"	NaturalSun+ LowE IG	PEL-N-229-01461-00001	4	4	argon	0.25	0.50	0.63	42	N				38	CA
	with grilles-between-the-glass	PEL-N-229-01462-00001				0.26	0.45	0.56	42	N					
	with Simulated Divided Light	PEL-N-229-01463-00001				0.26	0.45	0.56	42	N					

R-Value = 1/U-Factor  
 SHGC = Solar Heat Gain Coefficient  
 VLT % = Visible Light Transmission  
 CR = Condensation Resistance  
 ER = Canadian Energy Rating

(1) Glazing performance values are calculated based on NFRC 100, NFRC 200 and NFRC 500. ENERGY STAR® values are updated to 2023 (version 7) criteria.

(2) The values shown are based on Canada's updated ENERGY STAR® 2020 initiative. Visit [www.energystar.gov](http://www.energystar.gov) for Energy Star guidelines.

Climate Zones

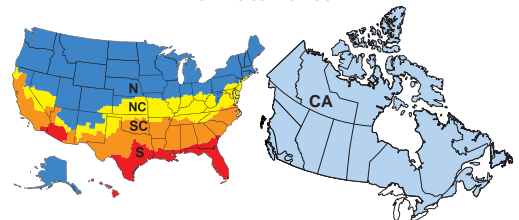



# Lifestyle Series Double-Hung

## Glazing Performance - Total Unit

Glazing Thickness	Type of Glazing	NFRC Certified Product #	Glass (mm)		Gap Fill	Performance Values <sup>1</sup>				Shaded Areas Meet ENERGY STAR® Performance Criteria in Zones Shown						
			Ext.	Int.		U-Factor	SHGC	VLT	CR	U. S.				Canada <sub>2</sub>		
										Zone				ER	Zone	
Dual-Pane Fixed – High Altitude Glazing										N	NC	SC	S	CA		
11/16"	Advanced LowE IG	PEL-N-229-00857-00001	2.5	2.5	air	0.31	0.31	0.58	54							
	with grilles-between-the-glass	PEL-N-229-00858-00001				0.31	0.28	0.52	54							
	with Simulated Divided Light	PEL-N-229-00859-00001				0.32	0.28	0.52	54							
11/16"	Advanced LowE IG	PEL-N-229-00945-00001	3	3	air	0.31	0.31	0.58	53							
	with grilles-between-the-glass	PEL-N-229-00946-00001				0.31	0.28	0.51	53							
	with Simulated Divided Light	PEL-N-229-00947-00001				0.32	0.28	0.51	53							
11/16"	Advanced LowE IG	PEL-N-229-00961-00001	4	4	air	0.33	0.31	0.57	51							
	with grilles-between-the-glass	PEL-N-229-00962-00001				0.34	0.28	0.51	51							
	with Simulated Divided Light	PEL-N-229-00963-00001				0.34	0.28	0.51	51							
11/16"	SunDefense™ Low-E IG	PEL-N-229-01041-00001	2.5	2.5	air	0.31	0.23	0.54	55				S			
	with grilles-between-the-glass	PEL-N-229-01042-00001				0.31	0.21	0.48	55				S			
	with Simulated Divided Light	PEL-N-229-01043-00001				0.28	0.21	0.48	53			SC	S			
11/16"	SunDefense Low-E IG	PEL-N-229-01049-00001	3	3	air	0.31	0.23	0.53	54				S			
	with grilles-between-the-glass	PEL-N-229-01050-00001				0.31	0.21	0.48	54				S			
	with Simulated Divided Light	PEL-N-229-01051-00001				0.32	0.21	0.48	54				S			
11/16"	SunDefense Low-E IG	PEL-N-229-01057-00001	4	4	air	0.32	0.23	0.53	52				S			
	with grilles-between-the-glass	PEL-N-229-01058-00001				0.34	0.21	0.47	52							
	with Simulated Divided Light	PEL-N-229-01059-00001				0.34	0.21	0.47	52							
11/16"	SunDefense+ Low-E IG	PEL-N-229-01489-00001	2.5	2.5	air	0.25	0.23	0.53	42		NC	SC	S			
	with grilles-between-the-glass	PEL-N-229-01490-00001				0.25	0.21	0.47	42		NC	SC	S			
	with Simulated Divided Light	PEL-N-229-01491-00001				0.26	0.21	0.47	42			SC	S			
11/16"	SunDefense+ Low-E IG	PEL-N-229-01497-00001	3	3	air	0.26	0.23	0.52	41			SC	S			
	with grilles-between-the-glass	PEL-N-229-01498-00001				0.26	0.21	0.47	41			SC	S			
	with Simulated Divided Light	PEL-N-229-01499-00001				0.27	0.21	0.47	41			SC	S			
11/16"	SunDefense+ Low-E IG	PEL-N-229-01505-00001	4	4	air	0.27	0.23	0.52	39			SC	S			
	with grilles-between-the-glass	PEL-N-229-01506-00001				0.28	0.21	0.46	39			SC	S			
	with Simulated Divided Light	PEL-N-229-01507-00001				0.28	0.21	0.46	39			SC	S			
11/16"	AdvancedComfort Low-E IG	PEL-N-229-00993-00001	2.5	2.5	air	0.26	0.30	0.57	42							
	with grilles-between-the-glass	PEL-N-229-00994-00001				0.26	0.27	0.51	42							
	with Simulated Divided Light	PEL-N-229-00995-00001				0.26	0.27	0.51	42							
11/16"	AdvancedComfort Low-E IG	PEL-N-229-01001-00001	3	3	air	0.26	0.30	0.56	41							
	with grilles-between-the-glass	PEL-N-229-01002-00001				0.26	0.27	0.50	41							
	with Simulated Divided Light	PEL-N-229-01003-00001				0.27	0.27	0.50	41							
11/16"	AdvancedComfort Low-E IG	PEL-N-229-01009-00001	4	4	air	0.27	0.30	0.55	39							
	with grilles-between-the-glass	PEL-N-229-01010-00001				0.28	0.27	0.50	39							
	with Simulated Divided Light	PEL-N-229-01011-00001				0.28	0.27	0.50	39							
11/16"	NaturalSun LowE IG	PEL-N-229-00897-00001	2.5	2.5	air	0.32	0.57	0.66	54							
	with grilles-between-the-glass	PEL-N-229-00898-00001				0.32	0.52	0.59	54							
	with Simulated Divided Light	PEL-N-229-00899-00001				0.33	0.52	0.59	54							
11/16"	NaturalSun LowE IG	PEL-N-229-00905-00001	3	3	air	0.32	0.56	0.65	53							
	with grilles-between-the-glass	PEL-N-229-00906-00001				0.32	0.51	0.58	53							
	with Simulated Divided Light	PEL-N-229-00907-00001				0.33	0.51	0.58	53							
11/16"	NaturalSun LowE IG	PEL-N-229-00913-00001	4	4	air	0.34	0.55	0.65	51							
	with grilles-between-the-glass	PEL-N-229-00914-00001				0.35	0.49	0.58	51							
	with Simulated Divided Light	PEL-N-229-00915-00001				0.35	0.49	0.58	51							
11/16"	NaturalSun+ LowE IG	PEL-N-229-01441-00001	2.5	2.5	air	0.26	0.52	0.64	41	N					37	CA
	with grilles-between-the-glass	PEL-N-229-01442-00001				0.26	0.47	0.58	41	N					35	CA
	with Simulated Divided Light	PEL-N-229-01443-00001				0.27	0.47	0.58	41							
11/16"	NaturalSun+ LowE IG	PEL-N-229-01449-00001	3	3	air	0.27	0.51	0.64	40						36	CA
	with grilles-between-the-glass	PEL-N-229-01450-00001				0.27	0.46	0.57	40							
	with Simulated Divided Light	PEL-N-229-01451-00001				0.28	0.46	0.57	40							
11/16"	NaturalSun+ LowE IG	PEL-N-229-01457-00001	4	4	air	0.28	0.50	0.63	38						34	CA
	with grilles-between-the-glass	PEL-N-229-01458-00001				0.29	0.45	0.56	38							
	with Simulated Divided Light	PEL-N-229-01459-00001				0.29	0.45	0.56	38							

(1) Glazing performance values are calculated based on NFRC 100, NFRC 200 and NFRC 500. ENERGY STAR® values are updated to 2023 (version 7) criteria.

(2) The values shown are based on Canada's updated ENERGY STAR® 2020 initiative. Visit [www.energystar.gov](http://www.energystar.gov) for Energy Star guidelines.

R-Value = 1/U-Factor  
 SHGC = Solar Heat Gain Coefficient  
 VLT % = Visible Light Transmission  
 CR = Condensation Resistance  
 ER = Canadian Energy Rating



Grille Profiles

Simulated-Divided-Light Grilles

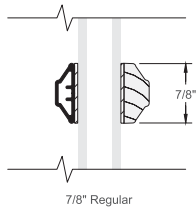

Simulated-Divided-Light Grilles with optional spacer

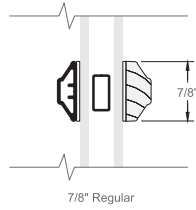

Grilles-Between-the-Glass

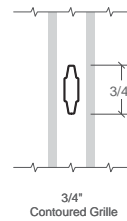

Grille Patterns

Grilles-Between-the-Glass and Simulated-Divided-Light Grilles

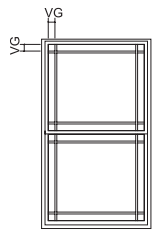

9-Lite Prairie

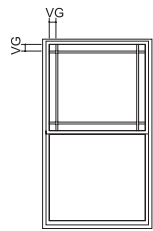

9-Lite Prairie Top Sash Only

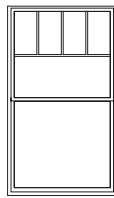

Top Row

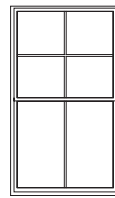

Cross

9-Lite Prairie

- Standard corner lite dimension for Prairie patterns = 2-1/2" VG.
- Available in transoms ≥ 1'3" height and width.

Cross

- Minimum DH frame height 35".
- Horizontal bar will be at 1/2" of the VG height of the top sash.

Top Row

- Minimum DH frame height 35".
- Horizontal bar will be at 1/2" of the VG height of the top sash.

For traditional patterns, see size tables.

VG = Visible Glass

(1) Grilles are available in traditional patterns only.

Lite dimensions noted can vary.

For size and pattern availability contact your local Pella sales representative.



# Lifestyle Series Double-Hung

## Size Tables - Double-Hung with GBG's and SDL's<sub>1</sub>

### Vent Units

	(552) (533)	(654) (635)	(755) (737)	(857) (838)	(959) (940)	(1 060) (1 041)	(1 162) (1 143)	(1 238) (1 219)
Opening	1' 9 3/4"	2' 1 3/4"	2' 5 3/4"	2' 9 3/4"	3' 1 3/4"	3' 5 3/4"	3' 9 3/4"	4' 0 3/4"
Frame	1' 9"	2' 1"	2' 5"	2' 9"	3' 1"	3' 5"	3' 9"	4' 0"
(908) (889)								
(1 060) (1 041)								
(1 213) (1 194)								
(1 365) (1 346)								
(1 467) (1 448)								
(1 517) (1 499)								
(1 670) (1 651)								
(1 822) (1 803)								
(1 975) (1 956)								
(2 153) (2 134)								

**Egress Notes:**  
 Check all applicable local codes for emergency egress requirements.

E = Window meets minimum clear opening of 24" height, 20" width, and 5.7 ft<sup>2</sup>.

E1 = Window meets minimum clear opening of 24" height, 20" width, and 5.0 ft<sup>2</sup>.

See Design Data pages in this section for clear opening dimensions.

Not to scale.

(1) Simulated divided lights are available in traditional patterns only.

Traditional grille patterns shown.

Grille patterns shown will align with grilles-between-the-glass on companion units.



# Lifestyle Series Double-Hung

## Size Tables - Fixed and Transoms with GBG's and SDL's

### Transoms

	(552) (533)	(654) (635)	(755) (737)	(857) (838)	(959) (940)	(1 060) (1 041)
Opening	1' 9 3/4"	2' 1 3/4"	2' 5 3/4"	2' 9 3/4"	3' 1 3/4"	3' 5 3/4"
Frame	1' 9"	2' 1"	2' 5"	2' 9"	3' 1"	3' 5"
(374) (356)						
(451) (432)						
(552) (533)						
(654) (635)						
(756) (737)						

### Fixed Units

	(1 060) (1 041)	(1 213) (1 194)	(1 365) (1 346)	(1 517) (1 499)	(1 060) (1 041)	(1 213) (1 194)	(1 365) (1 346)	(1 517) (1 499)
Opening	3' 5 3/4"	3' 11 3/4"	4' 5 3/4"	4' 11 3/4"	3' 5 3/4"	3' 11 3/4"	4' 5 3/4"	4' 11 3/4"
Frame	3' 5"	3' 11"	4' 5"	4' 11"	3' 5"	3' 11"	4' 5"	4' 11"
(908) (889)								
(1 060) (1 041)								
(1 213) (1 194)								
(1 365) (1 346)								
(1 467) (1 448)								

Not to scale.

Traditional grille patterns shown.





















Grille patterns shown will align with grilles-between-the-glass on companion units.



























































# Lifestyle Series Double-Hung

## Size Tables - Replacement Sizes with Grilles-Between-the-Glass

### Transoms

	(616) (597)	(718) (699)	(762) (749)	(819) (800)	(921) (902)	(1 022) (1 003)	(1 073) (1 054)
Opening	2' 0 1/4"	2' 4 1/4"	2' 6 1/4"	2' 8 1/4"	3' 0 1/4"	3' 4 1/4"	3' 6 1/4"
Frame	1' 11 1/2"	2' 3 1/2"	2' 5 1/2"	2' 7 1/2"	2' 11 1/2"	3' 3 1/2"	3' 5 1/2"
(375) (356)	 23.5 x 14	 27.5 x 14	 29.5 x 14	 31.5 x 14	 35.5 x 14	 39.5 x 14	 41.5 x 14
(451) (432)	 23.5 x 17	 27.5 x 17	 29.5 x 17	 31.5 x 17	 35.5 x 17	 39.5 x 17	 41.5 x 17
(654) (635)	 23.5 x 25	 27.5 x 25	 29.5 x 25	 31.5 x 25	 35.5 x 25	 39.5 x 25	 41.5 x 25

### Vent Units

(921) (902)	 23.5 x 35.5	 27.5 x 35.5	 29.5 x 35.5	 31.5 x 35.5	 35.5 x 35.5	 39.5 x 35.5	 41.5 x 35.5
(972) (953)	 23.5 x 37.5	 27.5 x 37.5	 29.5 x 37.5	 31.5 x 37.5	 35.5 x 37.5	 39.5 x 37.5	 41.5 x 37.5
(1 073) (1 054)	 23.5 x 41.5	 27.5 x 41.5	 29.5 x 41.5	 31.5 x 41.5	 35.5 x 41.5	 39.5 x 41.5	 41.5 x 41.5
(1 175) (1 156)	 23.5 x 45.5	 27.5 x 45.5	 29.5 x 45.5	 31.5 x 45.5	 35.5 x 45.5	 39.5 x 45.5	 41.5 x 45.5
(1 226) (1 206)	 23.5 x 47.5	 27.5 x 47.5	 29.5 x 47.5	 31.5 x 47.5	 35.5 x 47.5	 39.5 x 47.5	 41.5 x 47.5
(1 327) (1 308)	 23.5 x 51.5	 27.5 x 51.5	 29.5 x 51.5	 31.5 x 51.5	 35.5 x 51.5	 39.5 x 51.5	 41.5 x 51.5
(1 378) (1 359)	 23.5 x 53.5	 27.5 x 53.5	 29.5 x 53.5	 31.5 x 53.5	 35.5 x 53.5	 39.5 x 53.5	 41.5 x 53.5
(1 473) (1 461)	 23.5 x 57.5	 27.5 x 57.5	 29.5 x 57.5	 31.5 x 57.5 E <sub>1</sub>	 35.5 x 57.5 E	 39.5 x 57.5 E	 41.5 x 57.5 E

#### Egress Notes:

Check all applicable local codes for emergency egress requirements.

E = Window meets minimum clear opening of 24" height, 20" width, and 5.7 ft<sup>2</sup>.

E<sub>1</sub> = Window meets minimum clear opening of 24" height, 20" width, and 5.0 ft<sup>2</sup>.

See Design Data pages in this section for clear opening dimensions.

Not to scale.











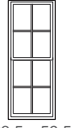
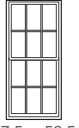
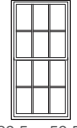
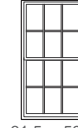
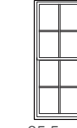

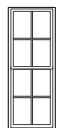
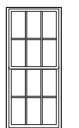
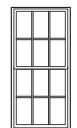
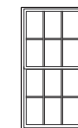

Traditional grille patterns shown.

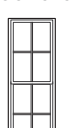
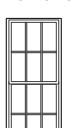
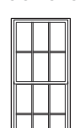
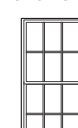

# Lifestyle Series Double-Hung

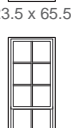
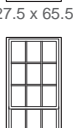
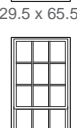
## Size Tables - Replacement Double-Hung with Grilles-Between-the-Glass

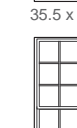
### Vent Units

	(616) (597)	(718) (699)	(762) (749)	(819) (800)	(921) (902)	(1 022) (1 003)	(1 073) (1 054)
Opening	2' 0 1/4"	2' 4 1/4"	2' 6 1/4"	2' 8 1/4"	3' 0 1/4"	3' 4 1/4"	3' 6 1/4"
Frame	1' 11 1/2"	2' 3 1/2"	2' 5 1/2"	2' 7 1/2"	2' 11 1/2"	3' 3 1/2"	3' 5 1/2"
(1 530) (1 511)	 23.5 x 59.5	 27.5 x 59.5	 29.5 x 59.5	 31.5 x 59.5 E <sub>1</sub>	 35.5 x 59.5 E	 39.5 x 59.5 E	 41.5 x 59.5 E
(1 581) (1 562)	 23.5 x 61.5	 27.5 x 61.5	 29.5 x 61.5 E <sub>1</sub>	 31.5 x 61.5 E <sub>1</sub>	 35.5 x 61.5 E	 39.5 x 61.5 E	 41.5 x 61.5 E
(1 683) (1 664)	 23.5 x 65.5	 27.5 x 65.5	 29.5 x 65.5 E <sub>1</sub>	 31.5 x 65.5 E	 35.5 x 65.5 E	 39.5 x 65.5 E	 41.5 x 65.5 E
(1 835) (1 816)	 23.5 x 71.5	 27.5 x 71.5 E <sub>1</sub>	 29.5 x 71.5 E	 31.5 x 71.5 E	 35.5 x 71.5 E	 39.5 x 71.5 E	 41.5 x 71.5 E
	5' 0 1/4"	5' 2 1/4"	5' 6 1/4"	6' 0 1/4"	5' 11 1/2"	5' 11 1/2"	5' 11 1/2"
	4' 11 1/2"	5' 1 1/2"	5' 5 1/2"	5' 11 1/2"	5' 11 1/2"	5' 11 1/2"	5' 11 1/2"

#### Egress Notes:

Check all applicable local codes for emergency egress requirements.

E = Window meets minimum clear opening of 24" height, 20" width, and 5.7 ft<sup>2</sup>.

E<sub>1</sub> = Window meets minimum clear opening of 24" height, 20" width, and 5.0 ft<sup>2</sup>.

See Design Data pages in this section for clear opening dimensions.

Not to scale.

Traditional grille patterns shown.



# Lifestyle Series Double-Hung

## Size Tables - Replacement Fixed with Grilles-Between-the-Glass

	(1 060) (1 041)	(1 213) (1 194)	(1 365) (1 346)	(1 517) (1 499)		(1 060) (1 041)	(1 213) (1 194)	(1 365) (1 346)	(1 517) (1 499)
Opening	3' 5 3/4"	3' 11 3/4"	4' 5 3/4"	4' 11 3/4"	Opening	3' 5 3/4"	3' 11 3/4"	4' 5 3/4"	4' 11 3/4"
Frame	3' 5"	3' 11"	4' 5"	4' 11"	Frame	3' 5"	3' 11"	4' 5"	4' 11"
(921) (902)					(1 530) (1 511)				
(972) (953)					(1 581) (1 562)				
(1 073) (1 054)					(1 683) (1 664)				
(1 175) (1 156)					(1 835) (1 816)				
(1 226) (1 206)									
(1 327) (1 308)									
(1 378) (1 359)									
(1 473) (1 461)									
	41 x 35.5	47 x 35.5	53 x 35.5	59 x 35.5		41 x 59.5	47 x 59.5	53 x 59.5	59 x 59.5
	41 x 37.5	47 x 37.5	53 x 37.5	59 x 37.5		41 x 61.5	47 x 61.5	53 x 61.5	59 x 61.5
	41 x 41.5	47 x 41.5	53 x 41.5	59 x 41.5		41 x 65.5	47 x 65.5	53 x 65.5	59 x 65.5
	41 x 45.5	47 x 45.5	53 x 45.5	59 x 45.5		41 x 71.5	47 x 71.5	53 x 71.5	59 x 71.5
	41 x 47.5	47 x 47.5	53 x 47.5	59 x 47.5					
	41 x 51.5	47 x 51.5	53 x 51.5	59 x 51.5					
	41 x 53.5	47 x 53.5	53 x 53.5	59 x 53.5					
	41 x 57.5	47 x 57.5	53 x 57.5	59 x 57.5					

### Egress Notes:

Check all applicable local codes for emergency egress requirements.

E = Window meets minimum clear opening of 24" height, 20" width, and 5.7 ft<sup>2</sup>.

E1 = Window meets minimum clear opening of 24" height, 20" width, and 5.0 ft<sup>2</sup>.

See Design Data pages in this section for clear opening dimensions.

Not to scale.

Traditional grille patterns shown.





Special Size Frame Dimensions\*

	Minimum	Maximum
Vent	1' 9" W x 2' 11" H (21" x 35") (533 x 889)	4' 0" W x 7' 0" H (48" x 84") (1 219 x 2 134)
Fixed	1' 9" W x 1' 2" H (21" x 14") (533 x 356)	4' 11" W x 6' 1" H (59" x 73") (1 499 x 1 854)

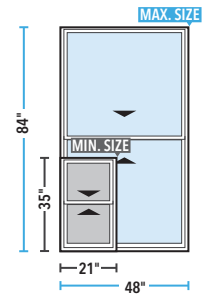

Miscellaneous Formulas (Equal Sash Only)

	Vent Units
Visible Glass	Width = Frame - 5" Height <sub>1</sub> = (Frame - 6.3125") ÷ 2
Actual Glass	Width = Frame - 4" Height <sub>1</sub> = (Frame - 4.3125") ÷ 2
Clear Opening Height:	(Frame Height ÷ 2) - 3.25"
Clear Opening Width:	Frame Width - 3.1875"

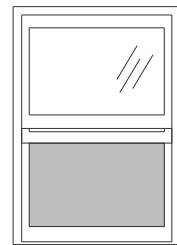
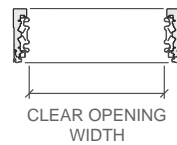

Shaded portion shows vent area.

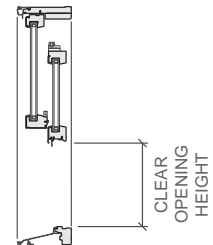

Miscellaneous Formulas (Fixed Units Only)

	Fixed and transom units
Visible Glass	Width = Frame - 4.9375" Height = Frame - 4.9375"
Actual Glass	Width = Frame - 4" Height = Frame - 4"

\* Available within size range shown. Keep frame dimensions to the nearest 1/4" increment. Frame height cannot exceed frame width on special size dual-pane vent units.  
(1) Per Sash.  
To convert areas to square meters (m<sup>2</sup>), multiply square feet by 0.0929.



# Lifestyle Series Double-Hung

## Design Data - Vent Units

New Construction Vent								
Unit	Egress	Clear Opening (Inches)		Vent Area Ft <sup>2</sup>	Visible Glass Ft <sup>2</sup>	Standard Glass Thickness (mm)		Performance Class & Grade <sup>(1)</sup>
		Width	Height			Annealed	Tempered	
2135		17-13/16	14-1/4	1.8	3.2	2.5	3	LC50
2141		17-13/16	17-1/4	2.1	3.9	2.5	3	LC50
2147		17-13/16	20-1/4	2.5	4.5	2.5	3	LC50
2153		17-13/16	23-1/4	2.9	5.2	2.5	3	LC50
2157		17-13/16	25-1/4	3.1	5.6	2.5	3	LC40/LC50
2159		17-13/16	26-1/4	3.2	5.9	2.5	3	LC40/LC50
2165		17-13/16	29-1/4	3.6	6.5	2.5	3	LC40/LC50
2171		17-13/16	32-1/4	4.0	7.2	2.5	3	LC30/LC50
2177		17-13/16	35-1/4	4.3	7.8	2.5	3	LC30
2184		17-13/16	38-3/4	4.8	8.6	2.5	3	LC25
2535		21-13/16	14-1/4	2.2	4.0	2.5	3	LC50
2541		21-13/16	17-1/4	2.6	4.8	2.5	3	LC50
2547		21-13/16	20-1/4	3.1	5.7	2.5	3	LC50
2553		21-13/16	23-1/4	3.5	6.5	2.5	3	LC50
2557		21-13/16	25-1/4	3.8	7.0	2.5	3	LC40/LC50
2559		21-13/16	26-1/4	4.0	7.3	2.5	3	LC40/LC50
2565		21-13/16	29-1/4	4.4	8.2	2.5	3	LC40/LC50
2571		21-13/16	32-1/4	4.9	9.0	2.5	3	LC30/LC50
2577	E1	21-13/16	35-1/4	5.3	9.8	2.5	3	LC30
2584	E	21-13/16	38-3/4	5.9	10.8	2.5	3	LC25
2935		25-13/16	14-1/4	2.6	4.8	2.5	3	LC50
2941		25-13/16	17-1/4	3.1	5.8	2.5	3	LC50
2947		25-13/16	20-1/4	3.6	6.8	2.5	3	LC50
2953		25-13/16	23-1/4	4.2	7.8	2.5	3	LC50
2957		25-13/16	25-1/4	4.5	8.4	2.5	3	LC40/LC50
2959		25-13/16	26-1/4	4.7	8.8	2.5	3	LC40/LC50
2965	E1	25-13/16	29-1/4	5.2	9.8	2.5	3	LC40/LC50
2971	E	25-13/16	32-1/4	5.8	10.8	2.5	3	LC30/LC50
2977	E	25-13/16	35-1/4	6.3	11.7	2.5	3	LC30
2984	E	25-13/16	38-3/4	6.9	12.9	2.5	3	LC25
3335		29-13/16	14-1/4	3.0	5.6	2.5	3	LC50
3341		29-13/16	17-1/4	3.6	6.7	2.5	3	LC50
3347		29-13/16	20-1/4	4.2	7.9	2.5	3	LC50
3353		29-13/16	23-1/4	4.8	9.1	2.5	3	LC40/LC50
3357	E1	29-13/16	25-1/4	5.2	9.9	2.5	3	LC40/LC50
3359	E1	29-13/16	26-1/4	5.4	10.2	2.5	3	LC40/LC50
3365	E	29-13/16	29-1/4	6.1	11.4	2.5	3	LC35/LC50
3371	E	29-13/16	32-1/4	6.7	12.6	2.5	3	LC30/LC50
3377	E	29-13/16	35-1/4	7.3	13.7	2.5	3	LC30
3384	E	29-13/16	38-3/4	8.0	15.1	2.5	3	LC25
3735		33-13/16	14-1/4	3.3	6.4	2.5	3	LC35/LC50
3741		33-13/16	17-1/4	4.1	7.7	2.5	3	LC35/LC50
3747		33-13/16	20-1/4	4.8	9.0	2.5	3	LC35/LC50
3753		33-13/16	23-1/4	5.5	10.4	2.5	3	LC35/LC50
3757	E	33-13/16	25-1/4	5.9	11.3	2.5	3	LC35/LC50
3759	E	33-13/16	26-1/4	6.2	11.7	2.5	3	LC35/LC50
3765	E	33-13/16	29-1/4	6.9	13.0	2.5	3	LC35/LC50
3771	E	33-13/16	32-1/4	7.6	14.4	2.5	3	LC30/LC50
3777	E	33-13/16	35-1/4	8.3	15.7	2.5	3	LC30
3784	E	33-13/16	38-3/4	9.1	17.3	2.5	3	LC25

**Egress Notes:**  
 Check all applicable local codes for emergency egress requirements.

- E = Window meets minimum clear opening of 24" height, 20" width, and 5.7 ft<sup>2</sup>.
- E1 = Window meets minimum clear opening of 24" height, 20" width, and 5.0 ft<sup>2</sup>.

Continued on Next Page

(1) Maximum performance when glazed with the appropriate glass thickness. Second number, where shown, indicates Design Pressure performance with DP Enhancement Kit installed. To convert area to square meters (m<sup>2</sup>), multiply square feet by 0.0929.



# Lifestyle Series Double-Hung

New Construction Vent								
Unit	Egress	Clear Opening (Inches)		Vent Area Ft <sup>2</sup>	Visible Glass Ft <sup>2</sup>	Standard Glass Thickness (mm)		Performance Class & Grade <sup>(1)</sup>
		Width	Height			Annealed	Tempered	
4135		37-13/16	14-1/4	3.7	6.5	2.5	3	LC30
4141		37-13/16	17-1/4	4.5	7.9	2.5	3	LC30
4147		37-13/16	20-1/4	5.3	9.2	2.5	3	LC30
4153		37-13/16	23-1/4	6.1	11.7	2.5	3	LC30
4157	E	37-13/16	25-1/4	6.6	12.7	2.5	3	LC30
4159	E	37-13/16	26-1/4	6.9	13.2	2.5	3	LC30
4165	E	37-13/16	29-1/4	7.7	14.7	2.5	3	LC30
4171	E	37-13/16	32-1/4	8.5	16.2	2.5	3	LC30
4177	E	37-13/16	35-1/4	9.2	17.6	2.5	3	LC30
4184	E	37-13/16	38-3/4	10.2	19.4	2.5	3	LC25
4535		41-13/16	14-1/4	4.1	8.0	2.5	3	LC30
4541		41-13/16	17-1/4	5.0	9.6	2.5	3	LC30
4547		41-13/16	20-1/4	5.9	11.3	2.5	3	LC30
4553		41-13/16	23-1/4	6.8	13.0	2.5	3	LC30
4557	E	41-13/16	25-1/4	7.3	14.1	2.5	3	LC30
4559	E	41-13/16	26-1/4	7.6	14.6	2.5	3	LC30
4565	E	41-13/16	29-1/4	8.5	16.3	2.5	3	LC30
4571	E	41-13/16	32-1/4	9.4	18.0	2.5	3	LC30
4577	E	41-13/16	35-1/4	10.2	19.6	2.5	3	LC30
4584	E	41-13/16	38-3/4	11.3	21.6	3.0	3	LC25
4835		44-13/16	14-1/4	4.4	8.6	2.5	3	LC25
4841		44-13/16	17-1/4	5.4	10.4	2.5	3	LC25
4847		44-13/16	20-1/4	6.3	12.1	2.5	3	LC25
4853		44-13/16	23-1/4	7.2	13.9	2.5	3	LC25
4857	E	44-13/16	25-1/4	7.9	15.1	2.5	3	LC25
4859	E	44-13/16	26-1/4	8.2	15.7	2.5	3	LC25
4865	E	44-13/16	29-1/4	9.1	17.5	2.5	3	LC25
4871	E	44-13/16	32-1/4	10.0	19.3	2.5	3	LC25
4877	E	44-13/16	35-1/4	11.0	21.1	2.5	3	LC25
4884	E	44-13/16	38-3/4	12.1	23.2	2.5	3	LC25

**Egress Notes:**

Check all applicable local codes for emergency egress requirements.

E = Window meets minimum clear opening of 24" height, 20" width, and 5.7 ft<sup>2</sup>.

E1 = Window meets minimum clear opening of 24" height, 20" width, and 5.0 ft<sup>2</sup>.

(1) Maximum performance when glazed with the appropriate glass thickness. Second number, where shown, indicates Design Pressure performance with DP Enhancement Kit installed. To convert area to square meters (m<sup>2</sup>), multiply square feet by 0.0929.



# Lifestyle Series Double-Hung

## Design Data - Fixed and Transoms

New Construction Fixed				
Unit	Visible Glass Ft <sup>2</sup>	Standard Glass Thickness (mm)		Performance Class & Grade <sup>(1)</sup>
		Annealed	Tempered	
4135	7.5	3	3	LC50
4141	9.0	3	3	LC50
4147	10.5	3	3	LC50
4153	12.0	3	3	LC50
4157	13.0	3	3	LC50
4159	13.6	3	3	LC50
4165	15.1	3	3	LC50
4171	16.6	3	3	LC45/LC50
4735	8.8	3	3	LC50
4741	10.5	3	3	LC50
4747	12.3	3	3	LC50
4753	14.1	3	3	LC50
4757	15.2	3	3	LC50
4759	15.8	3	3	LC45/LC50
4765	17.6	3	3	LC45/LC50
4771	19.3	4	4	LC50
5335	10.0	3	3	LC50
5341	12.0	3	3	LC50
5347	14.1	3	3	LC50
5353	16.1	3	4	LC45/LC50
5357	17.4	3	4	LC45/LC50
5359	18.1	4	4	LC50
5365	20.1	4	4	LC50
5371	22.1	4	4	LC50
5935	11.3	3	3	LC50
5941	13.6	3	3	LC50
5947	15.8	3	3	LC45/LC50
5953	18.1	4	4	LC50
5957	19.6	4	4	LC50
5959	20.3	4	4	LC50
5965	22.6	4	4	LC50
5971	24.8	4	4	LC45/LC50

New Construction Fixed Transom				
Unit	Visible Glass Ft <sup>2</sup>	Standard Glass Thickness (mm)		Performance Class & Grade <sup>(1)</sup>
		Annealed	Tempered	
2114	1.0	3	3	LC50
2117	1.3	3	3	LC50
2121	1.8	3	3	LC50
2125	2.2	3	3	LC50
2514	1.3	3	3	LC50
2517	1.7	3	3	LC50
2525	2.8	3	3	LC50
2914	1.5	3	3	LC50
2917	2.0	3	3	LC50
2925	3.4	3	3	LC50
2929	4.0	3	3	LC50
3314	1.8	3	3	LC50
3317	2.4	3	3	LC50
3325	3.9	3	3	LC50
3714	2.0	3	3	LC50
3717	2.7	3	3	LC50
3725	4.5	3	3	LC50
4114	2.3	3	3	LC50
4117	3.0	3	3	LC50
4125	5.0	3	3	LC50

(1) Maximum performance when glazed with the appropriate glass thickness. Second number, where shown, requires tempered glass.  
To convert areas to square meters (m<sup>2</sup>), multiply square feet by 0.0929.



# Lifestyle Series Double-Hung

## Design Data - Replacement Double-Hung

Replacement Vent								
Unit	Egress	Clear Opening		Vent Area Ft <sup>2</sup>	Visible Glass Ft <sup>2</sup>	Standard Glass Thickness (mm)		Performance Class & Grade <sup>1</sup>
		Width (Inches)	Height (Inches)			Annealed	Tempered	
23.5 x 35.5		20-5/16	14-1/2	2.0	3.7	2.5	3	LC50
23.5 x 37.5		20-5/16	15-1/2	2.1	4.0	2.5	3	LC50
23.5 x 41.5		20-5/16	17-1/2	2.4	4.5	2.5	3	LC50
23.5 x 45.5		20-5/16	19-1/2	2.7	5.0	2.5	3	LC50
23.5 x 47.5		20-5/16	20-1/2	2.8	5.3	2.5	3	LC50
23.5 x 51.5		20-5/16	22-1/2	3.1	5.8	2.5	3	LC50
23.5 x 53.5		20-5/16	23-1/2	3.3	6.1	2.5	3	LC40/LC50
23.5 x 57.5		20-5/16	25-1/2	3.5	6.6	2.5	3	LC40/LC50
23.5 x 59.5		20-5/16	26-1/2	3.7	6.8	2.5	3	LC40/LC50
23.5 x 61.5		20-5/16	27-1/2	3.8	7.1	2.5	3	LC40/LC50
23.5 x 65.5		20-5/16	29-1/2	4.1	7.6	2.5	3	LC30/LC50
23.5 x 71.5		20-5/16	32-1/2	4.5	8.4	2.5	3	LC30/LC50
27.5 x 35.5		24-5/16	14-1/2	2.4	4.6	2.5	3	LC50
27.5 x 37.5		24-5/16	15-1/2	2.6	4.9	2.5	3	LC50
27.5 x 41.5		24-5/16	17-1/2	2.9	5.5	2.5	3	LC50
27.5 x 45.5		24-5/16	19-1/2	3.2	6.1	2.5	3	LC50
27.5 x 47.5		24-5/16	20-1/2	3.4	6.4	2.5	3	LC50
27.5 x 51.5		24-5/16	22-1/2	3.7	7.1	2.5	3	LC50
27.5 x 53.5		24-5/16	23-1/2	3.9	7.4	2.5	3	LC40/LC50
27.5 x 57.5		24-5/16	25-1/2	4.3	8.0	2.5	3	LC40/LC50
27.5 x 59.5		24-5/16	26-1/2	4.4	8.3	2.5	3	LC40/LC50
27.5 x 61.5		24-5/16	27-1/2	4.6	8.6	2.5	3	LC40/LC50
27.5 x 65.5		24-5/16	29-1/2	4.9	9.2	2.5	3	LC30/LC50
27.5 x 71.5	E1	24-5/16	32-1/2	5.4	10.2	2.5	3	LC30/LC50
29.5 x 35.5		26-5/16	14-1/2	2.6	5.0	2.5	3	LC50
29.5 x 37.5		26-5/16	15-1/2	2.8	5.3	2.5	3	LC50
29.5 x 41.5		26-5/16	17-1/2	3.1	6.0	2.5	3	LC50
29.5 x 45.5		26-5/16	19-1/2	3.5	6.7	2.5	3	LC50
29.5 x 47.5		26-5/16	20-1/2	3.7	7.0	2.5	3	LC40/LC50
29.5 x 51.5		26-5/16	22-1/2	4.1	7.7	2.5	3	LC40/LC50
29.5 x 53.5		26-5/16	23-1/2	4.2	8.0	2.5	3	LC40/LC50
29.5 x 57.5		26-5/16	25-1/2	4.6	8.7	2.5	3	LC40/LC50
29.5 x 59.5		26-5/16	26-1/2	4.8	9.0	2.5	3	LC35/LC50
29.5 x 61.5	E1	26-5/16	27-1/2	5.0	9.4	2.5	3	LC35/LC50
29.5 x 65.5	E1	26-5/16	29-1/2	5.3	10.1	2.5	3	LC30/LC50
29.5 x 71.5	E	26-5/16	32-1/2	5.9	11.1	2.5	3	LC30/LC50

**Egress Notes:**

Check all applicable local codes for emergency egress requirements.

E = Window meets minimum clear opening of 24" height, 20" width, and 5.7 ft<sup>2</sup>.

E1 = Window meets minimum clear opening of 24" height, 20" width, and 5.0 ft<sup>2</sup>.

(1) Maximum performance when glazed with the appropriate glass thickness. Second number, where shown, indicates Design Pressure performance with DP Enhancement Kit installed.



# Lifestyle Series Double-Hung

## Design Data - Replacement Double-Hung

Replacement Vent								
Unit	Egress	Clear Opening		Vent Area Ft <sup>2</sup>	Visible Glass Ft <sup>2</sup>	Standard Glass Thickness (mm)		Performance Class & Grade <sup>1</sup>
		Width (Inches)	Height (Inches)			Annealed	Tempered	
31.5 x 35.5		28-5/16	14-1/2	2.8	5.4	2.5	3	LC50
31.5 x 37.5		28-5/16	15-1/2	3.0	5.7	2.5	3	LC50
31.5 x 41.5		28-5/16	17-1/2	3.4	6.5	2.5	3	LC50
31.5 x 45.5		28-5/16	19-1/2	3.8	7.2	2.5	3	LC50
31.5 x 47.5		28-5/16	20-1/2	4.0	7.6	2.5	3	LC40/LC50
31.5 x 51.5		28-5/16	22-1/2	4.4	8.3	2.5	3	LC40/LC50
31.5 x 53.5		28-5/16	23-1/2	4.6	8.7	2.5	3	LC40/LC50
31.5 x 57.5	E1	28-5/16	25-1/2	5.0	9.4	2.5	3	LC40/LC50
31.5 x 59.5	E1	28-5/16	26-1/2	5.2	9.8	2.5	3	LC35/LC50
31.5 x 61.5	E1	28-5/16	27-1/2	5.4	10.2	2.5	3	LC35/LC50
31.5 x 65.5	E	28-5/16	29-1/2	5.8	10.9	2.5	3	LC30/LC50
31.5 x 71.5	E	28-5/16	32-1/2	6.3	12.0	2.5	3	LC30/LC50
35.5 x 35.5		32-5/16	14-1/2	3.2	6.2	2.5	3	LC35/LC50
35.5 x 37.5		32-5/16	15-1/2	3.4	6.6	2.5	3	LC35/LC50
35.5 x 41.5		32-5/16	17-1/2	3.9	7.5	2.5	3	LC35/LC50
35.5 x 45.5		32-5/16	19-1/2	4.3	8.3	2.5	3	LC35/LC50
35.5 x 47.5		32-5/16	20-1/2	4.6	8.7	2.5	3	LC35/LC50
35.5 x 51.5		32-5/16	22-1/2	5.0	9.6	2.5	3	LC35/LC50
35.5 x 53.5		32-5/16	23-1/2	5.2	10.0	2.5	3	LC35/LC50
35.5 x 57.5	E1	32-5/16	25-1/2	5.7	10.8	2.5	3	LC35/LC50
35.5 x 59.5	E	32-5/16	26-1/2	5.9	11.3	2.5	3	LC35/LC50
35.5 x 61.5	E	32-5/16	27-1/2	6.1	11.7	2.5	3	LC35/LC50
35.5 x 65.5	E	32-5/16	29-1/2	6.6	12.5	2.5	3	LC30/LC50
35.5 x 71.5	E	32-5/16	32-1/2	7.2	13.8	2.5	3	LC30/LC50
39.5 x 35.5		36-5/16	14-1/2	3.6	7.0	2.5	3	LC30
39.5 x 37.5		36-5/16	15-1/2	3.9	7.5	2.5	3	LC30
39.5 x 41.5		36-5/16	17-1/2	4.4	8.4	2.5	3	LC30
39.5 x 45.5		36-5/16	19-1/2	4.9	9.4	2.5	3	LC30
39.5 x 47.5		36-5/16	20-1/2	5.1	9.9	2.5	3	LC30
39.5 x 51.5		36-5/16	22-1/2	5.6	10.8	2.5	3	LC30
39.5 x 53.5		36-5/16	23-1/2	5.9	11.3	2.5	3	LC30
39.5 x 57.5	E	36-5/16	25-1/2	6.4	12.3	2.5	3	LC30
39.5 x 59.5	E	36-5/16	26-1/2	6.6	12.7	2.5	3	LC30
39.5 x 61.5	E	36-5/16	27-1/2	6.9	13.2	2.5	3	LC30
39.5 x 65.5	E	36-5/16	29-1/2	7.4	14.2	2.5	3	LC30
39.5 x 71.5	E	36-5/16	32-1/2	8.1	15.6	2.5	3	LC30
41.5 x 35.5		38-5/16	14-1/2	3.6	7.4	2.5	3	LC30
41.5 x 37.5		38-5/16	15-1/2	3.9	7.9	2.5	3	LC30
41.5 x 41.5		38-5/16	17-1/2	4.4	8.9	2.5	3	LC30
41.5 x 45.5		38-5/16	19-1/2	4.9	9.9	2.5	3	LC30
41.5 x 47.5		38-5/16	20-1/2	5.1	10.4	2.5	3	LC30
41.5 x 51.5		38-5/16	22-1/2	5.6	11.5	2.5	3	LC30
41.5 x 53.5		38-5/16	23-1/2	5.9	12.0	2.5	3	LC30
41.5 x 57.5	E	38-5/16	25-1/2	6.4	13.0	2.5	3	LC30
41.5 x 59.5	E	38-5/16	26-1/2	6.6	13.5	2.5	3	LC30
41.5 x 61.5	E	38-5/16	27-1/2	6.9	14.0	2.5	3	LC30
41.5 x 65.5	E	38-5/16	29-1/2	7.4	15.0	2.5	3	LC30
41.5 x 71.5	E	38-5/16	32-1/2	8.1	16.5	2.5	3	LC30

### Egress Notes:

Check all applicable local codes for emergency egress requirements.

- E = Window meets minimum clear opening of 24" height, 20" width, and 5.7 ft<sup>2</sup>.
- E1 = Window meets minimum clear opening of 24" height, 20" width, and 5.0 ft<sup>2</sup>.

(1) Maximum performance when glazed with the appropriate glass thickness. Second number, where shown, indicates Design Pressure performance with DP Enhancement Kit installed.



# Lifestyle Series Double-Hung

## Design Data - Replacement Fixed and Transoms

Replacement Fixed				
Unit	Visible Glass Ft <sup>2</sup>	Standard Glass Thickness (mm)		Performance Class & Grade <sup>(1)</sup>
		Annealed	Tempered	
41 x 35.5	7.7	3	3	LC50
41 x 37.5	8.2	3	3	LC50
41 x 41.5	9.2	3	3	LC50
41 x 45.5	10.2	3	3	LC50
41 x 47.5	10.7	3	3	LC50
41 x 51.5	11.7	3	3	LC50
41 x 53.5	12.2	3	3	LC50
41 x 57.5	13.2	3	3	LC50
41 x 59.5	13.7	3	3	LC50
41 x 61.5	14.2	3	3	LC50
41 x 65.5	15.2	3	3	LC50
41 x 71.5	16.7	3	3	LC45/LC50
47 x 35.5	8.9	3	3	LC50
47 x 37.5	9.5	3	3	LC50
47 x 41.5	10.7	3	3	LC50
47 x 45.5	11.9	3	3	LC50
47 x 47.5	12.4	3	3	LC50
47 x 51.5	13.6	3	3	LC50
47 x 53.5	14.2	3	3	LC50
47 x 57.5	15.4	3	3	LC50
47 x 59.5	15.9	3	3	LC45/LC50
47 x 61.5	16.5	3	3	LC45/LC50
47 x 65.5	17.7	3	3	LC40/LC50
47 x 71.5	19.5	4	4	LC50
53 x 35.5	10.2	3	3	LC50
53 x 37.5	10.9	3	3	LC50
53 x 41.5	12.2	3	3	LC50
53 x 45.5	13.5	3	3	LC50
53 x 47.5	14.2	3	3	LC50
53 x 51.5	15.6	3	3	LC50
53 x 53.5	16.2	3	4	LC45/LC50
53 x 57.5	17.6	3	4	LC40/LC50
53 x 59.5	18.2	4	4	LC50
53 x 61.5	18.9	4	4	LC50
53 x 65.5	20.2	4	4	LC50
53 x 71.5	22.2	4	4	LC50
59 x 35.5	11.5	3	3	LC50
59 x 37.5	12.2	3	3	LC50
59 x 41.5	13.7	3	3	LC50
59 x 45.5	15.2	3	3	LC50
59 x 47.5	16.0	3	3	LC45/LC50
59 x 51.5	17.5	3	4	LC45/LC50
59 x 53.5	18.2	4	4	LC50
59 x 57.5	19.7	4	4	LC50
59 x 59.5	20.5	4	4	LC50
59 x 61.5	21.2	4	4	LC50
59 x 65.5	22.8	4	4	LC50
59 x 71.5	25.0	4	4	LC45/LC50

Replacement Fixed Transom				
Unit	Visible Glass Ft <sup>2</sup>	Standard Glass Thickness (mm)		Performance Class & Grade <sup>(1)</sup>
		Annealed	Tempered	
23.5 x 14	1.2	3	3	LC50
23.5 x 17	1.6	3	3	LC50
23.5 x 25	2.6	3	3	LC50
27.5 x 14	1.4	3	3	LC50
27.5 x 17	1.9	3	3	LC50
27.5 x 25	3.1	3	3	LC50
29.5 x 14	1.5	3	3	LC50
29.5 x 17	2.1	3	3	LC50
29.5 x 25	3.4	3	3	LC50
31.5 x 14	1.7	3	3	LC50
31.5 x 17	2.2	3	3	LC50
31.5 x 25	3.7	3	3	LC50
35.5 x 14	1.9	3	3	LC50
35.5 x 17	2.6	3	3	LC50
35.5 x 25	4.3	3	3	LC50
39.5 x 14	2.2	3	3	LC50
39.5 x 17	2.9	3	3	LC50
39.5 x 25	4.8	3	3	LC50
41.5 x 14	2.3	3	3	LC50
41.5 x 17	3.1	3	3	LC50
41.5 x 25	5.1	3	3	LC50

(1) Maximum performance when glazed with the appropriate glass thickness. Second number, where shown, requires tempered glass. To convert areas to square meters (m<sup>2</sup>), multiply square feet by 0.0929.



## Detailed Product Description

### Frame

- Select softwood, immersion treated with Pella's EnduraGuard® wood protection formula in accordance with WDMA I.S.-4. The EnduraGuard formula includes three active ingredients for protection against the effects of moisture, decay, stains from mold and mildew. Plus, an additional ingredient adds protection against termite damage.
- Interior exposed surfaces are clear pine.
- Exterior surfaces are clad with aluminum.
- Components are assembled with screws, staples and concealed corner locks.
- Overall frame depth is 5" (127 mm) for a wall depth of 3-11/16" (94mm).
- Jamb liner shall be high-impact polyvinyl chloride backed by continuous hard-tempered aluminum springs.
- Optional factory applied jamb extensions are available.
- Optional factory installed fold-out installation fins with flexible fin corners.
- Optional factory-applied EnduraClad® exterior trim.
- Optional factory-installed Pella Steady Set Installation System.

### Sash

- Select softwood, immersion treated with Pella's EnduraGuard® wood protection formula in accordance with WDMA I.S.-4. The EnduraGuard formula includes three active ingredients for protection against the effects of moisture, decay, stains from mold and mildew. Plus, an additional ingredient adds protection against termite damage.
- Interior exposed surfaces are clear pine.
- Exterior surfaces are clad with aluminum, lap-jointed and sealed.
- Corners mortised and tenoned, glued and secured with metal fasteners.
- Sash thickness is 1-5/8" (41 mm).
- Sashes tilt for easy cleaning.

### Weatherstripping

- Foam with 3 mm skin at head and bottom rail. Thermal-plastic elastomer bulb with slip-coating set into upper sash for tight contact at check rail.
- Secondary polyvinyl chloride leaf-type weatherstrip on bottom sash at sill.
- Jamb liner to seal against sides of sash.

### Glazing System

- Quality float glass complying with ASTM C 1036.
- High altitude glazing available.
- Silicone groove-glazed 1 1/16" [obscure] dual-seal insulating glass [[annealed] [tempered]] [[Advanced] [SunDefense™] [SunDefense+] [AdvancedComfort] [NaturalSun] [NaturalSun+] Low-E [with argon]].

### Exterior

- Exterior aluminum surfaces are finished with EnduraClad® protective finish, in a multi-step, baked-on finish.
- Color is [White] [Tan] [Putty] [Brown] [Poplar White] [Portobello] [Hartford Green] [Morning Sky Gray] [Brick Red] [Black].

### Interior

- [Unfinished, ready for site finishing] [factory primed with one coat acrylic latex] [factory prefinished [White] [Linen] [Bright White] [stain<sub>1</sub>]].

### Hardware

- Galvanized block-and-tackle balances are connected to sash with a polyester cord and concealed within the frame.
- Factory installed self-aligning surface-mounted sash lock. Two sash locks on units with frame width 33-1/4" and greater.
- Optional Sash lift furnished for field installation. Two lifts on units with frame width 33-1/4" and greater.
- Finish is [baked enamel [Champagne] [White] [Brown] [Matte Black]] [Satin Brass] [Satin Nickel].
- Champagne locks are standard on unfinished units; White locks are standard on factory prefinished white units.

### Optional Products

#### Grilles

- Simulated-Divided-Light [with optional spacer]
  - 7/8" Grilles permanently bonded to the interior and exterior of glass.
  - Patterns are [Traditional] [Prairie] [Cross] [Top Row] [Custom – Equally Divided].
  - Interior surfaces are [unfinished, ready for site finishing] [factory primed] [pine: factory prefinished [White] [Linen White] [Bright White] [stain<sub>1</sub>]]. Exterior grilles to match the exterior cladding color.
  - Available only on units glazed with Low-E insulated glass with argon.
- or –
- Grilles-Between-the-Glass<sub>2</sub>
  - Insulating glass contains 3/4" contoured aluminum grilles permanently installed between two panes of glass.
  - Patterns are [Traditional] [9-Lite Prairie] [Top Row] [Custom – Equally Divided].
  - Interior color is [White] [Ivory] [Tan<sub>3</sub>] [Brickstone] [Black] [Putty<sub>3</sub>] [Brown<sub>3</sub>] [Harvest] [Cordovan].
  - Exterior color [matched to the exterior cladding color] [White]<sub>4</sub>.

#### Screens

- InView™ screens
  - Full-size Vinyl-coated 18/18 mesh fiberglass screen cloth complying with the performance requirements of SMA 1201, set in aluminum frame fitted to outside of window, supplied complete with all necessary hardware.
  - Screen frame finish is baked enamel, color to match window cladding.
- Hidden screens<sub>5</sub>
  - Vinyl-coated 18/18 mesh fiberglass screen cloth, set in aluminum channels hidden within the sash, supplied complete with all necessary hardware.
  - Finish color [White] [Black] [Brown] [Fossil] [Iron Ore].

#### Hardware

- Optional factory applied limited opening device available for vent units in steel, nominal 3-3/4" opening.
- Optional window opening control device available for field installation. Device allows window to open less than 4" with normal operation, with a release mechanism that allows the sash to open completely. Complies with ASTM F2090-10.

#### Sensors

- Optional factory installed integrated security sensors available in vent units.

(1) Contact your local Pella sales representative for current designs and color options.

(2) Available on units glazed with Low-E insulated glass with argon, and obscure insulated glass.

(3) Tan, brown and putty Interior GBG colors are available only with matching interior and exterior colors.

(4) Appearance of exterior grille color will vary depending on Low-E coating on glass.

(5) Not compatible with Limited Opening Hardware.





# Lifestyle Series Double-Hung

## Unit Sections

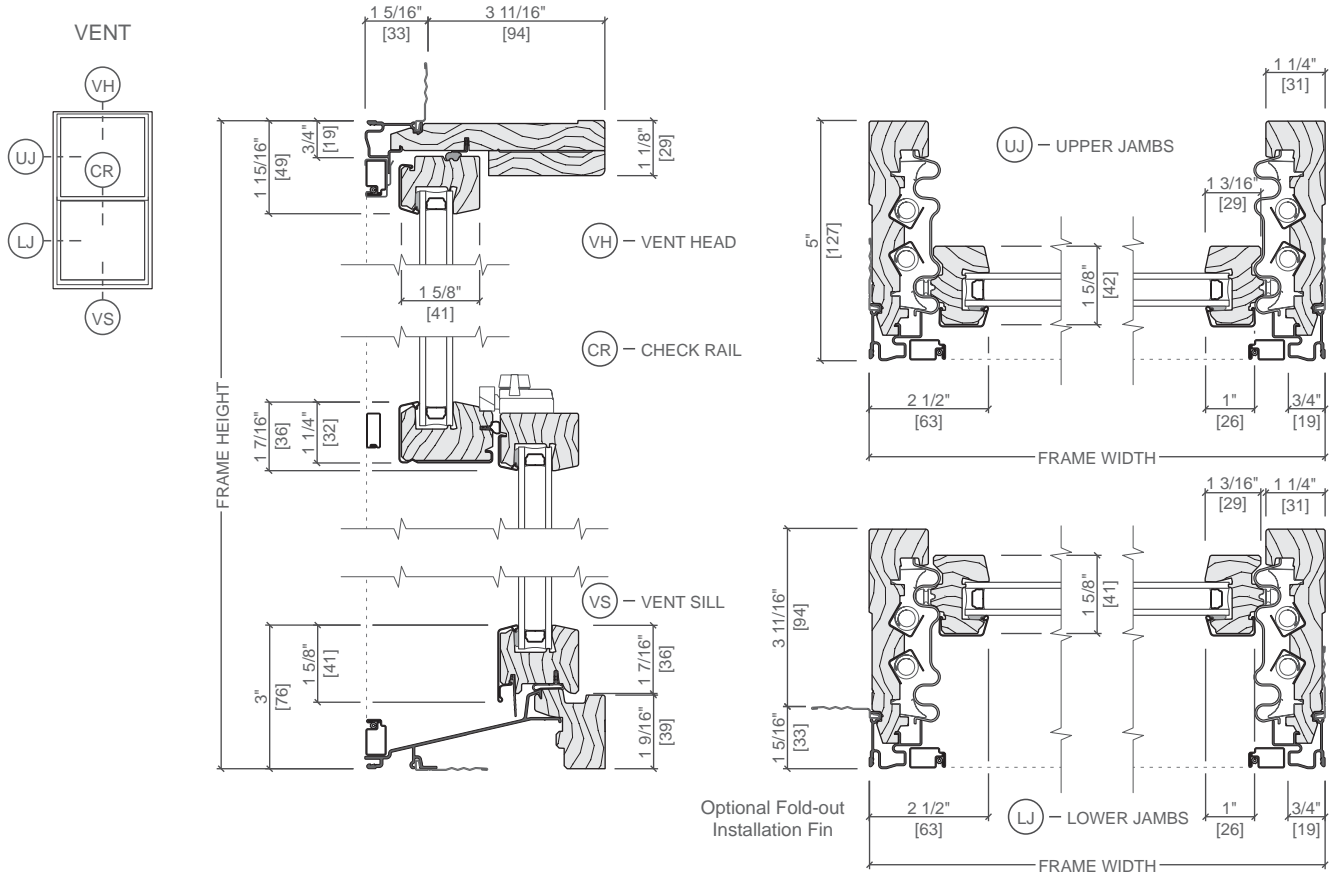

Scale 3" = 1' 0"  
 All dimensions are approximate.



# Lifestyle Series Double-Hung

## Unit Sections

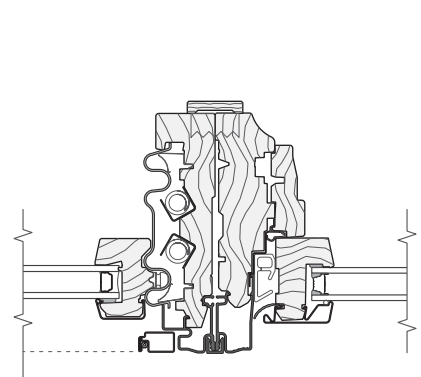
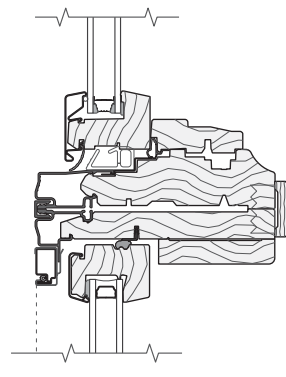
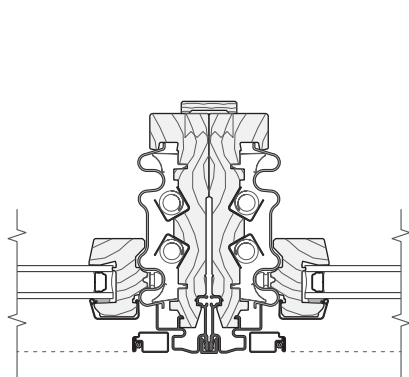
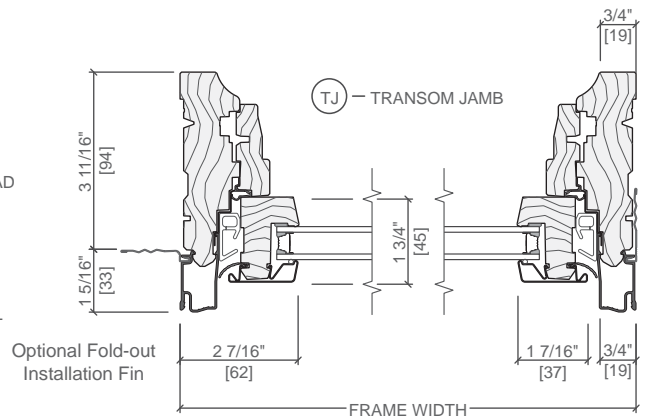
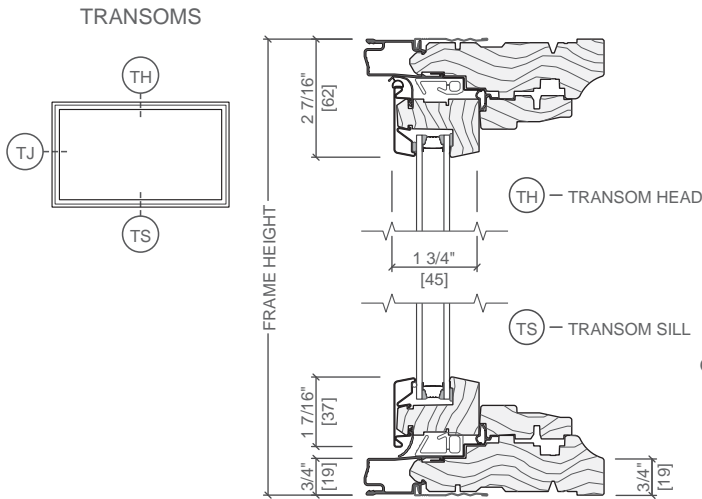
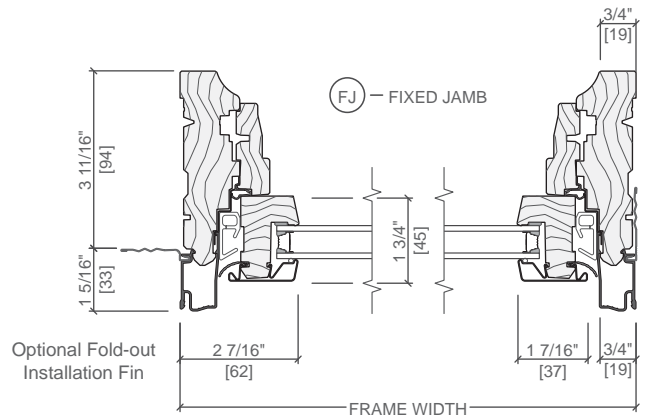
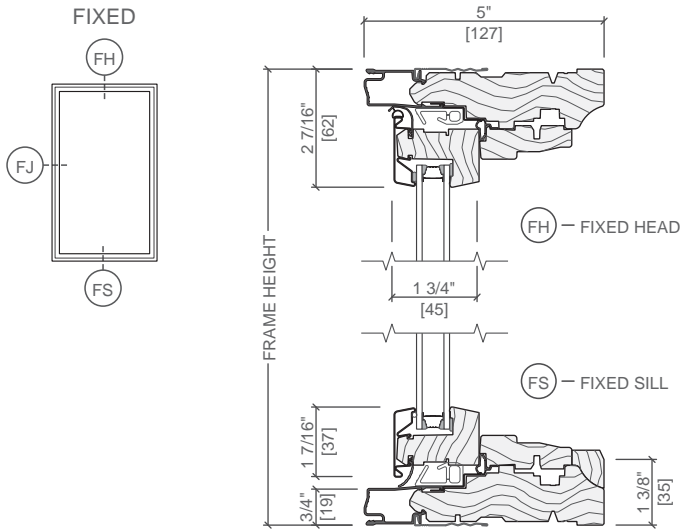

Scale 3" = 1' 0"

All dimensions are approximate.

See [www.Pella.com](http://www.Pella.com) for mullion limitations and reinforcing requirements.



# Lifestyle Series Double-Hung

## Unit Sections

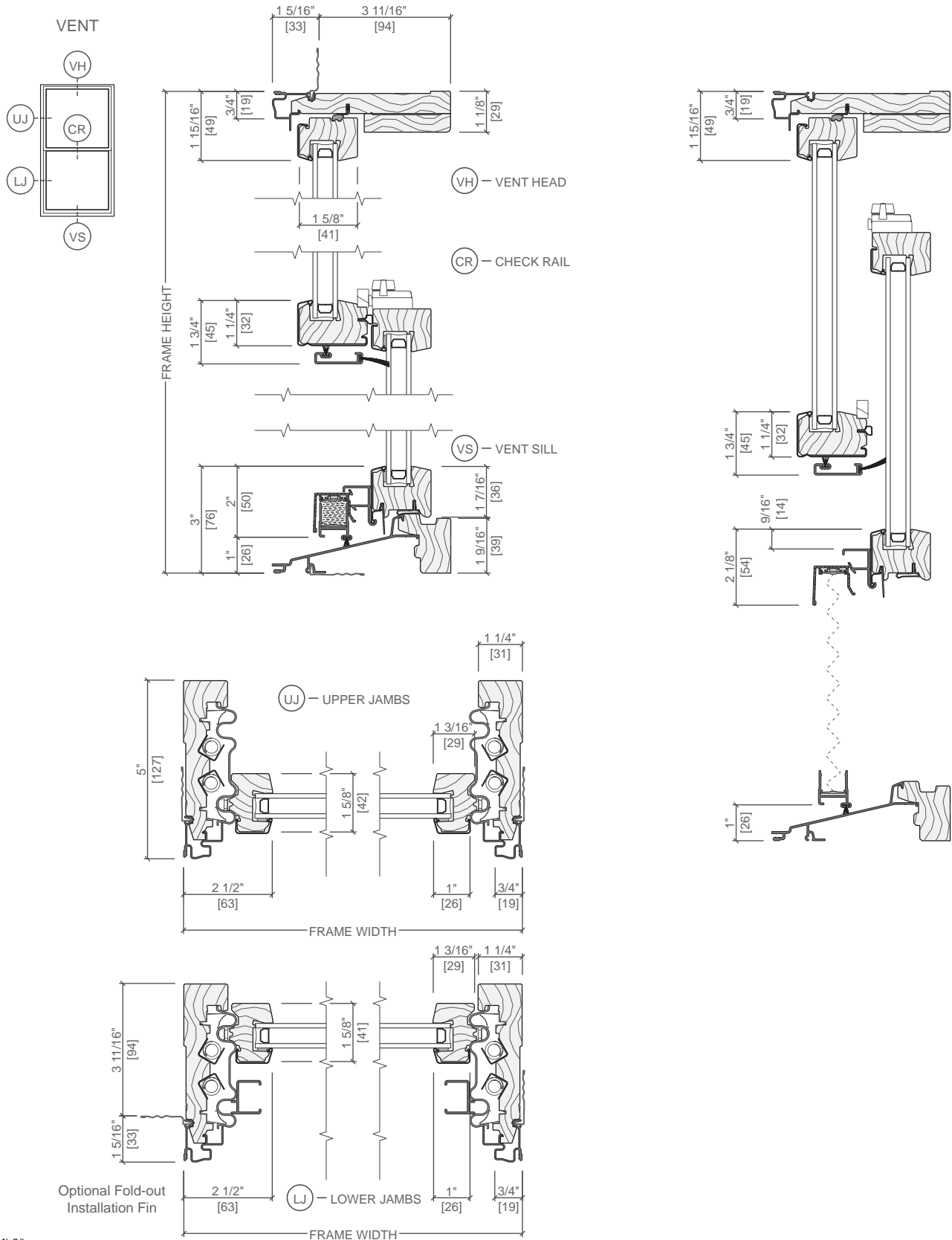

Scale 3" = 1' 0"  
 All dimensions are approximate.